

# LOTE 1

CROQUIS

PLANTA SÓTANO -1

GARAJE Nº 1 - 2 - 3

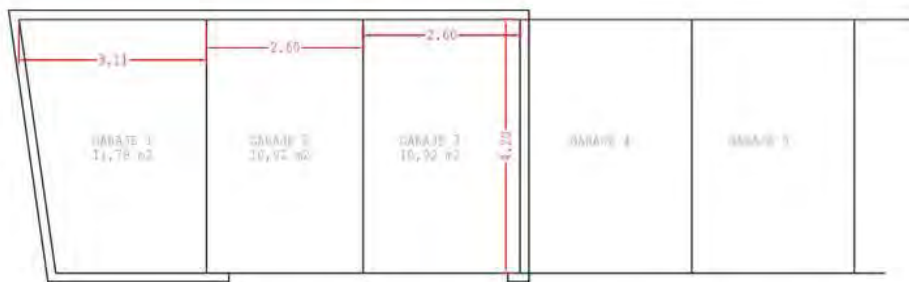

Escala gráfica



ENTORNO



ENTORNO



EXTERIOR EDIFICIO



EXTERIOR EDIFICIO



## ACCESO A GARAJES



## EXTERIOR PORTAL



## ACCESO A PLAZAS

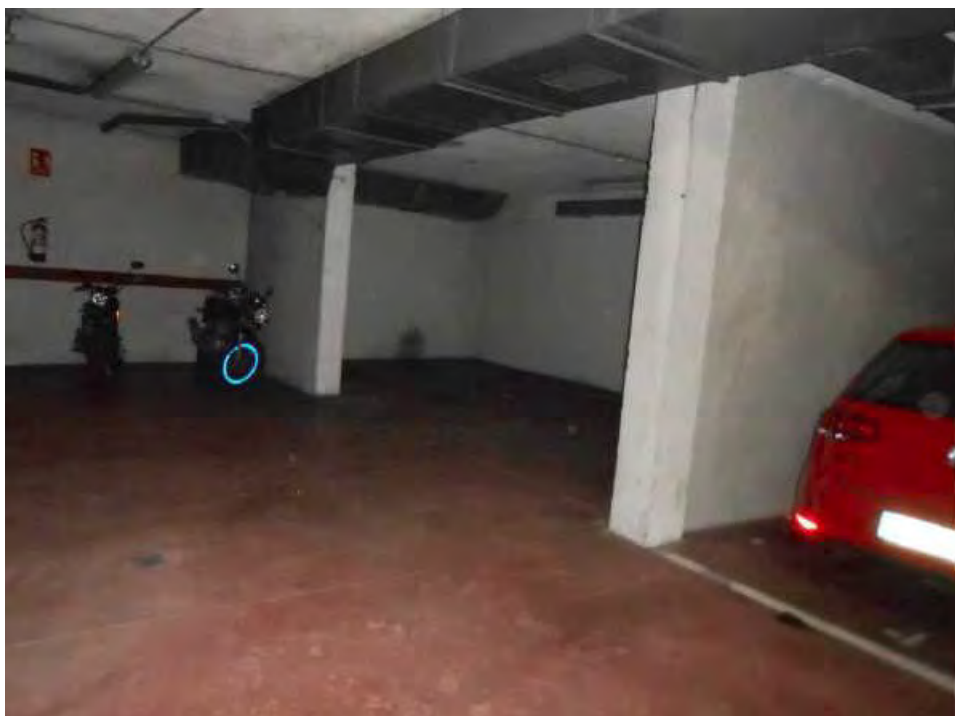

## GARAJES 1, 2, 3



TABIQUE PLAZA 1



INTERIOR PLAZA 1



## PLAZAS COLINDANTES



## LOTE 2

CROQUIS

PLANTA SÓTANO -1

GARAJE N° 1 - 2 - 3

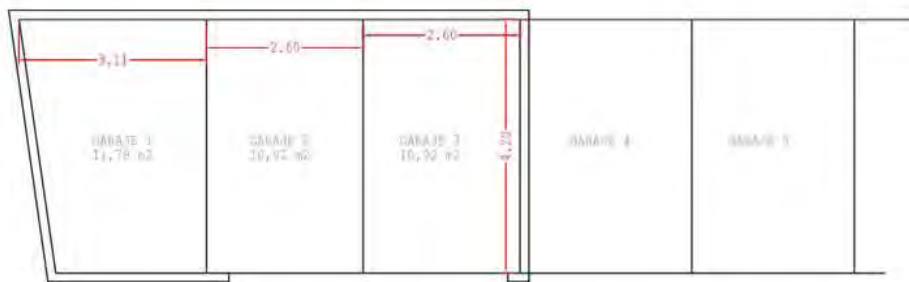

Escala gráfica





ENTORNO



ENTORNO



EXTERIOR EDIFICIO



EXTERIOR EDIFICIO



## ACCESO A GARAJES



## EXTERIOR PORTAL



ACCESO A PLAZAS

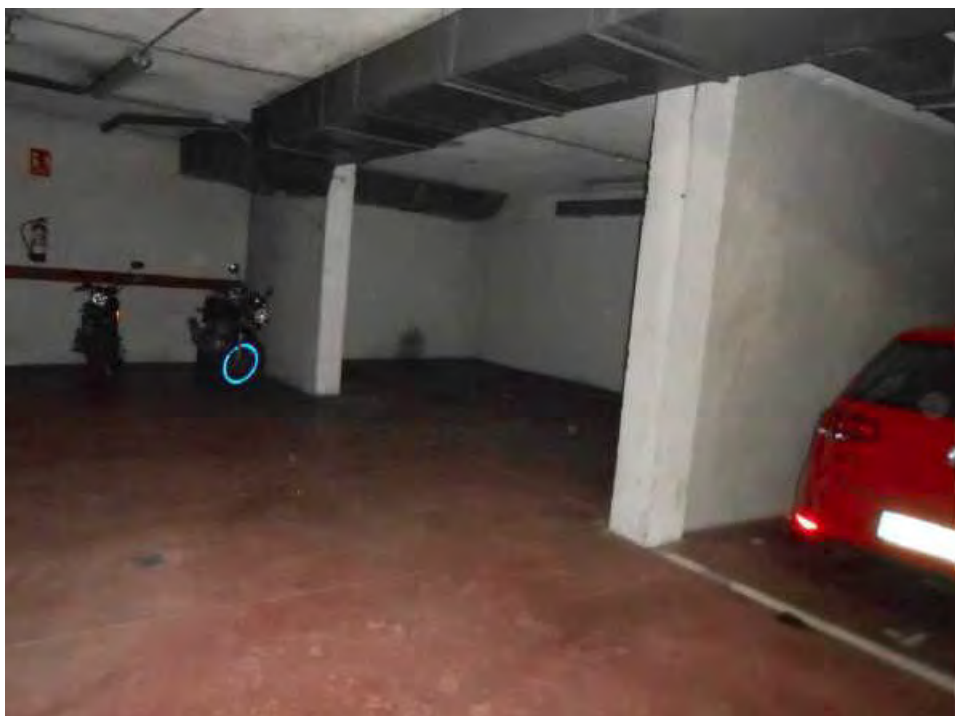

GARAJES 1, 2, 3



TABIQUE PLAZA 1

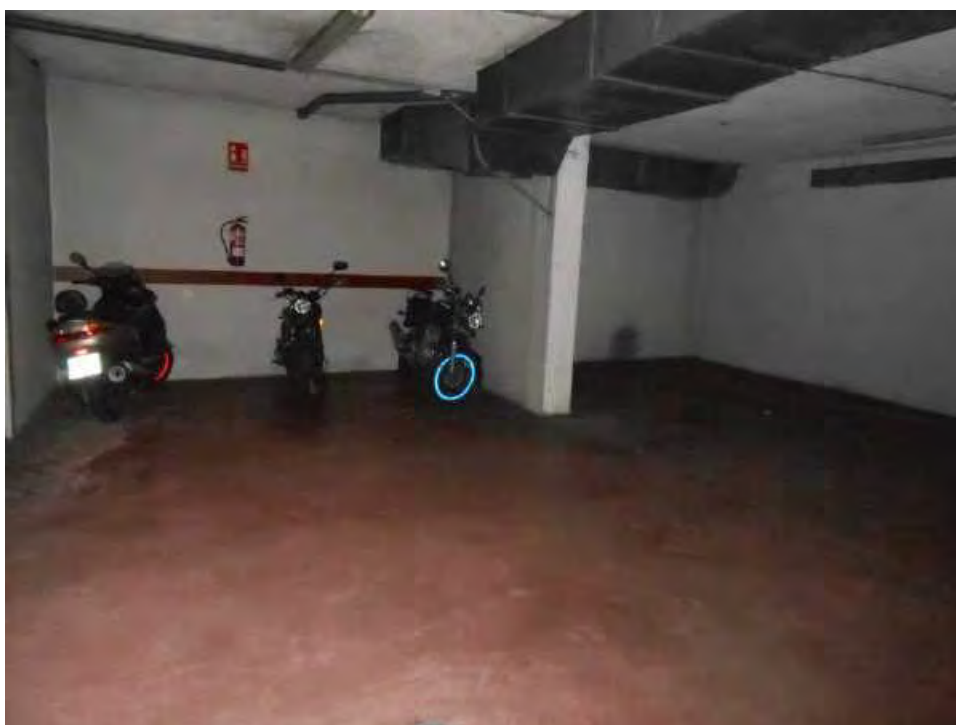

INTERIOR PLAZAS 2 Y 3

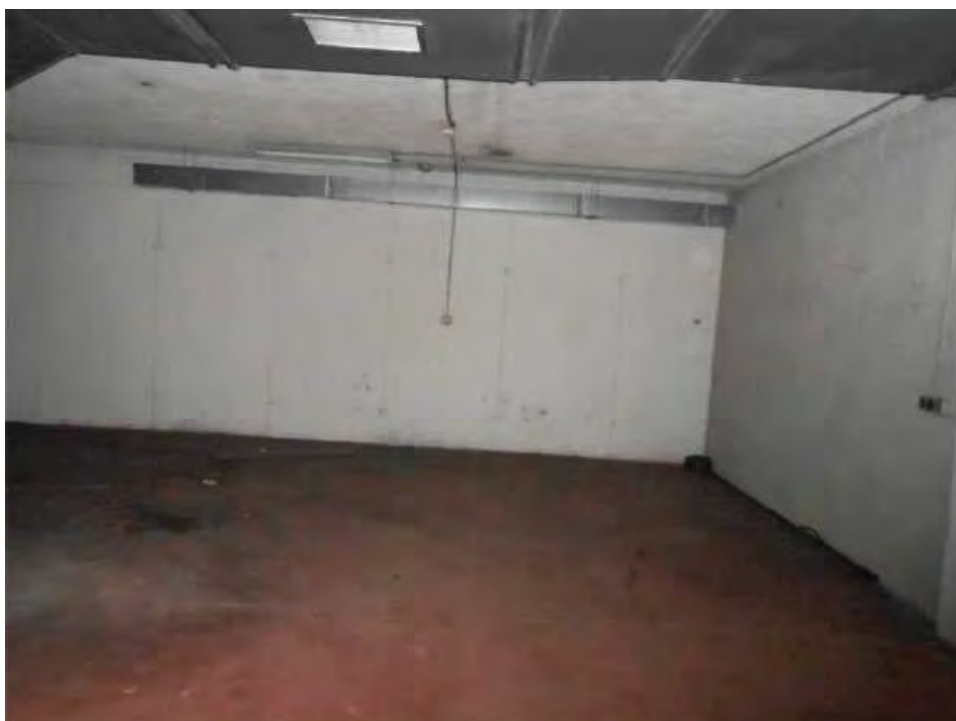

## PLAZAS COLINDANTES



# LOTE 3

CROQUIS

PLANTA SÓTANO -1

GARAJE N° 1 - 2 - 3

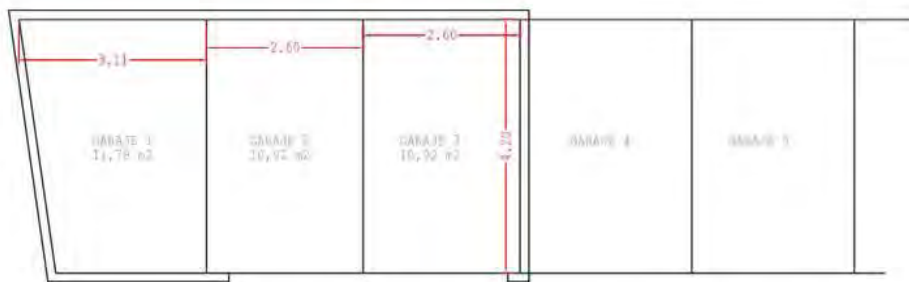

Escala gráfica



ENTORNO



ENTORNO





EXTERIOR EDIFICIO



EXTERIOR EDIFICIO



## ACCESO A GARAJES



## EXTERIOR PORTAL



ACCESO A PLAZAS

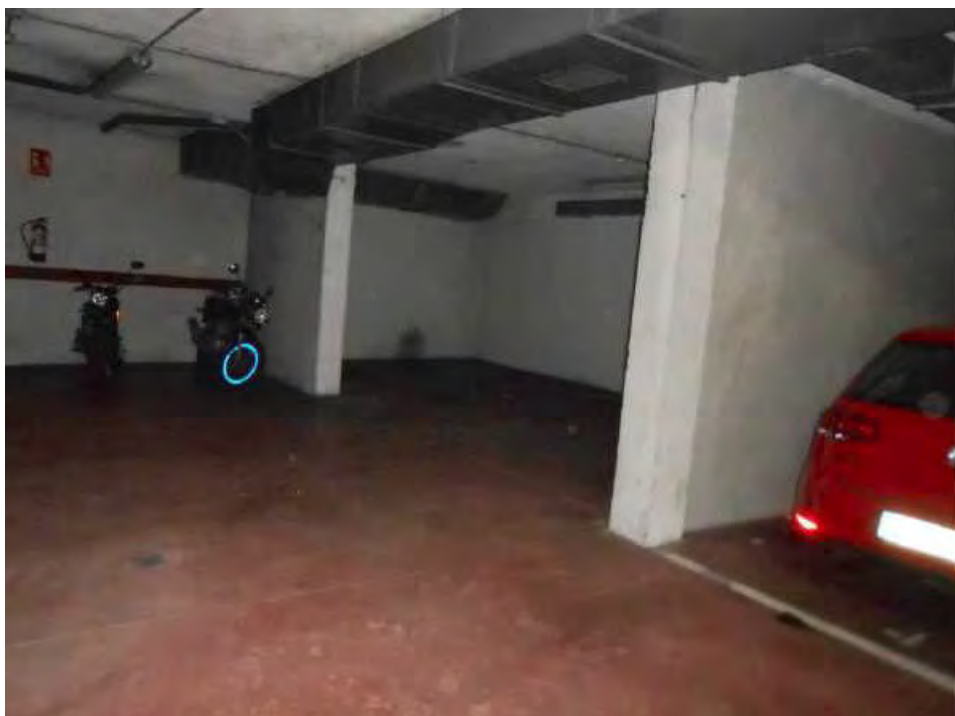

GARAJES 1, 2, 3



TABIQUE PLAZA 1

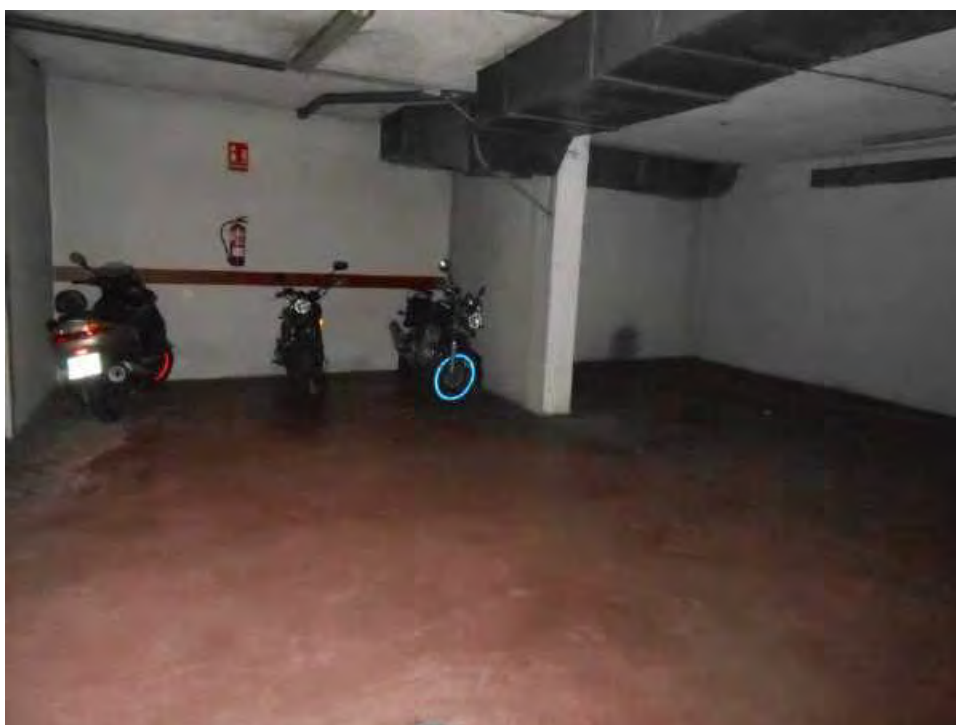

INTERIOR PLAZAS 2 Y 3

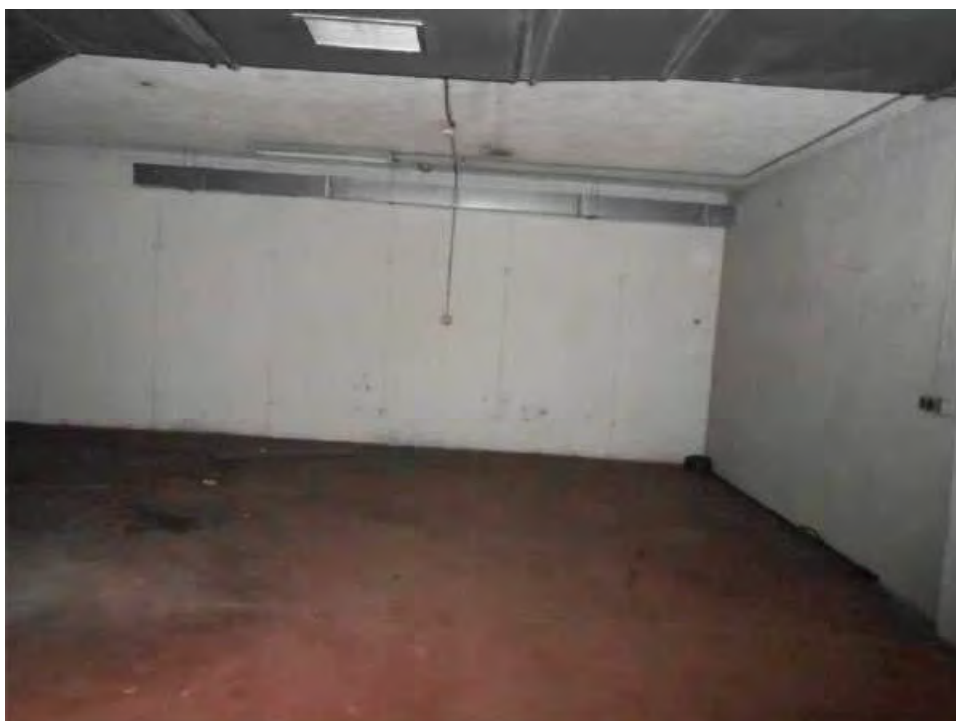

## PLAZAS COLINDANTES



## LOTE 4

EDIFICIO



PORTAL NÚMERO



PORTAL



PASILLOS COMUNES



ENTRADA PARKING



TRASTERO 44





TRASTERO 45



TRASTERO 46



PUERTA GENERAL TRASTEROS

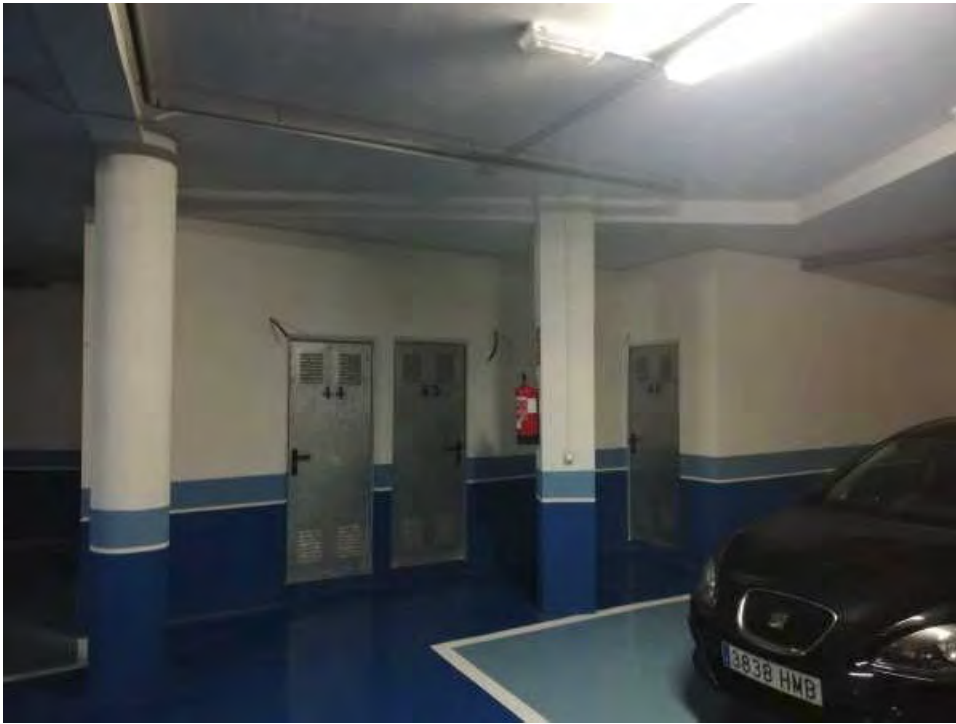

FONDO TRASTEROS

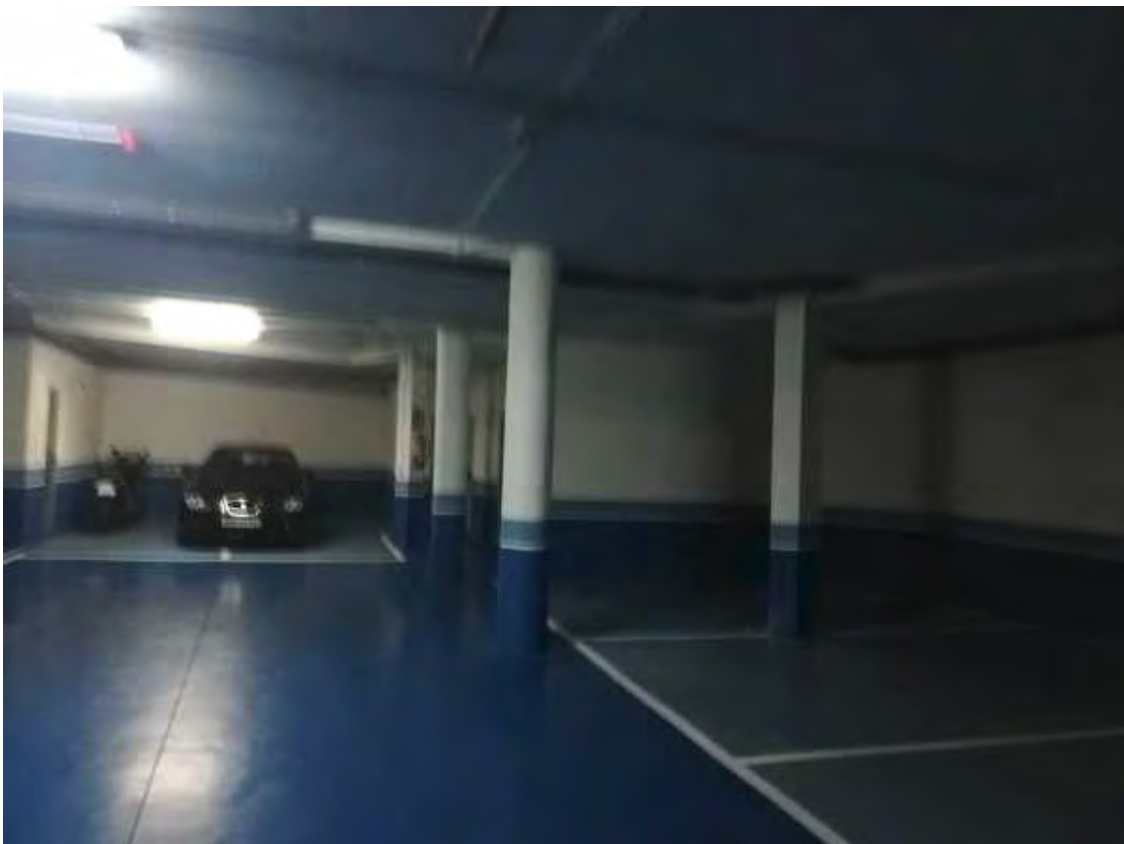

CROQUIS

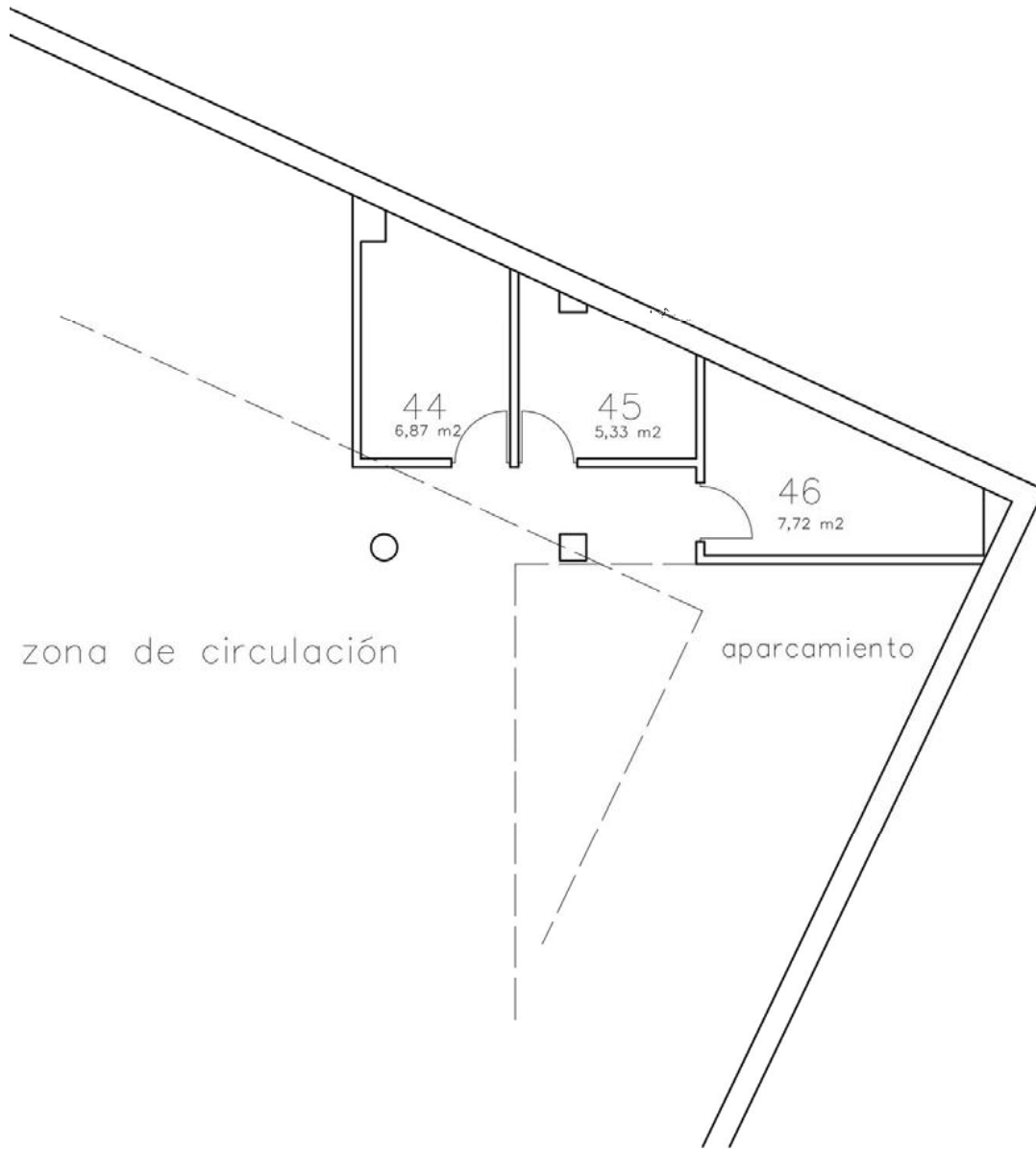

## LOTE 5

### ENTORNO



### EDIFICIO FACHADA PRINCIPAL



## EDIFICIO FACHADA POSTERIOR



## ACCESO A SÓTANO DESDE EXTERIOR



**EXTERIOR PORTAL**



**INTERIOR PORTAL**



## EXTERIOR TRASTEROS



TRASTERO N° 1



TRASTERO N° 2

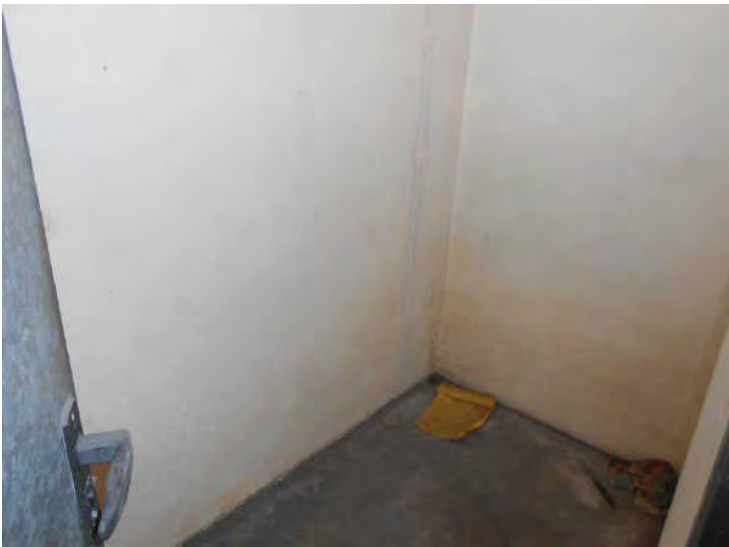

CROQUIS

# PLANTA SÓTANO -1

## TRASTERO N° 1 Y 2

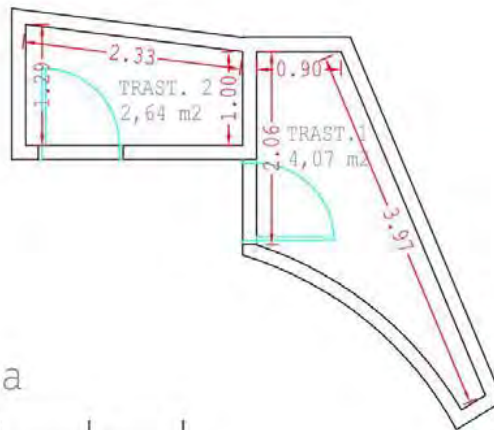

Escala gráfica







## LOTE 6

CROQUIS

PLANTA SÓTANO -2

TRASTERO Nº 7

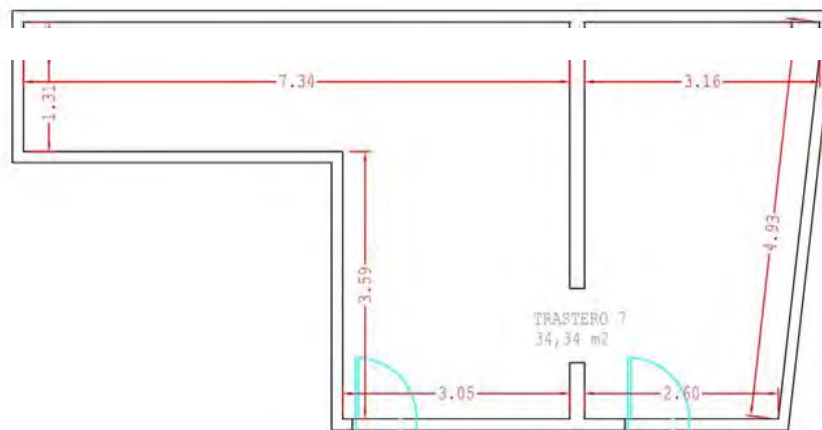

Escala gráfica



ENTORNO



EXTERIOR EDIFICIO



EXTERIOR EDIFICIO



ACCESO GARAJES Y TRASTEROS CALLE POSTERIOR



ACCESO PORTAL INTERIOR GALERÍA COMERCIAL



PORTAL ACCESO EDIFICIO

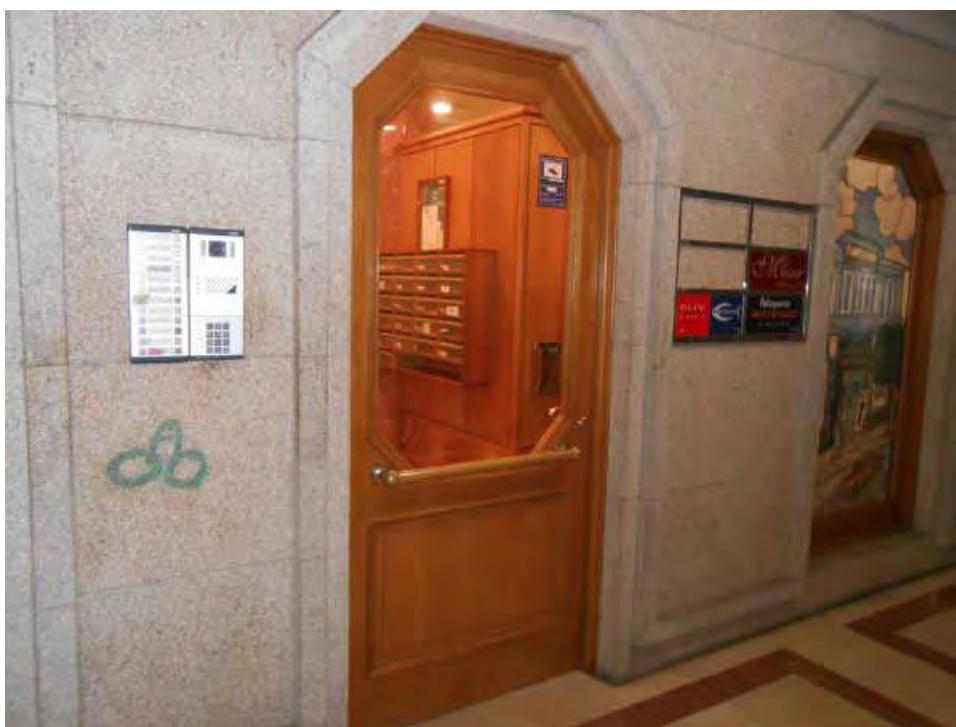

EXTERIOR TRASTERO



EXTERIOR TRASTERO



INTERIOR TRASTERO



INTERIOR TRASTERO



**LOTE 7**

CROQUIS

PLANTA SÓTANO -2  
GARAJES N° 38/39 y TRASTEROS 36/37

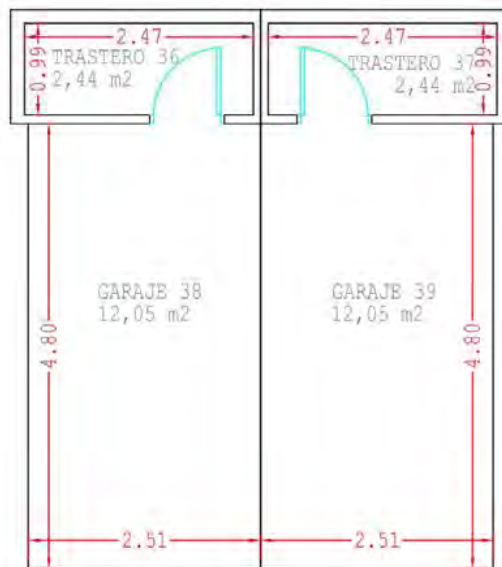

Escala gráfica





ENTORNO



ENTORNO



## EDIFICIO



## EDIFICIO Nº 22 PORTAL 2



EDIFICIO Nº 20 PORTAL 1



EXTERIOR ACCESO GARAJES



EXTERIOR PORTAL



INTERIOR PORTAL



PLAZAS 38 Y 39



TRASTERO 36



TRASTERO 37



## LOTE 8

CROQUIS

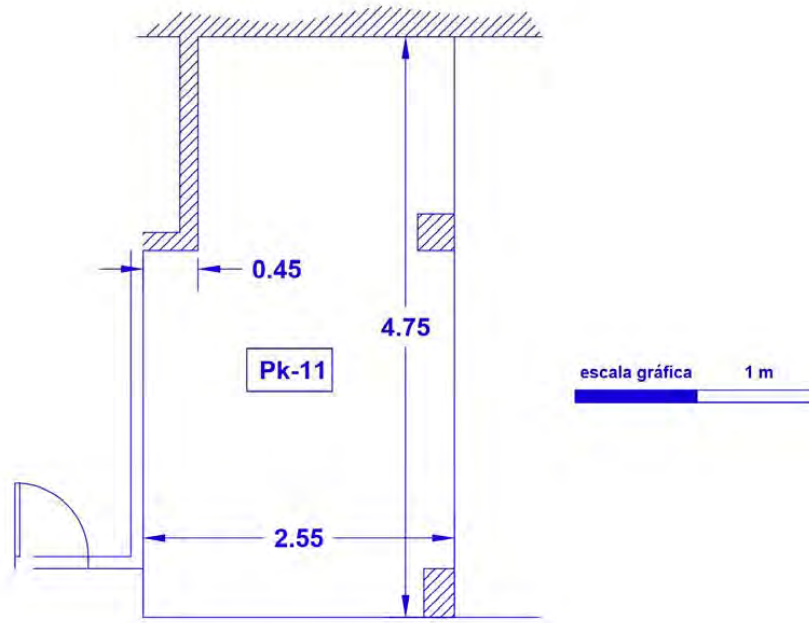

ENTORNO



## ENTORNO



## EXTERIOR





## ACCESO AL APARCAMIENTO



## VISTA DEL GARAJE

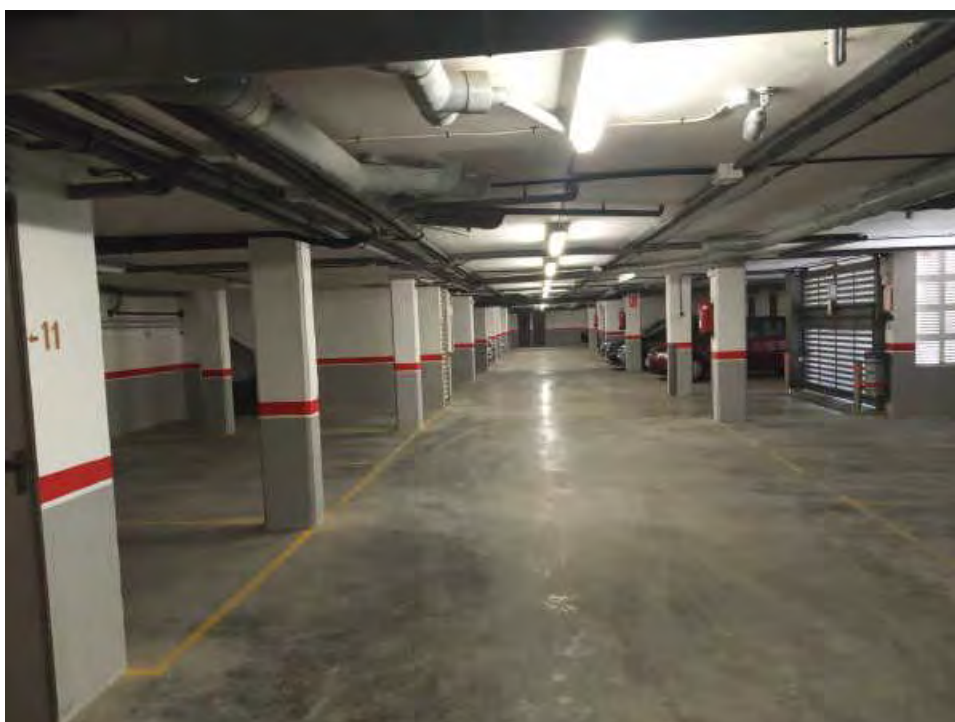

PLAZA

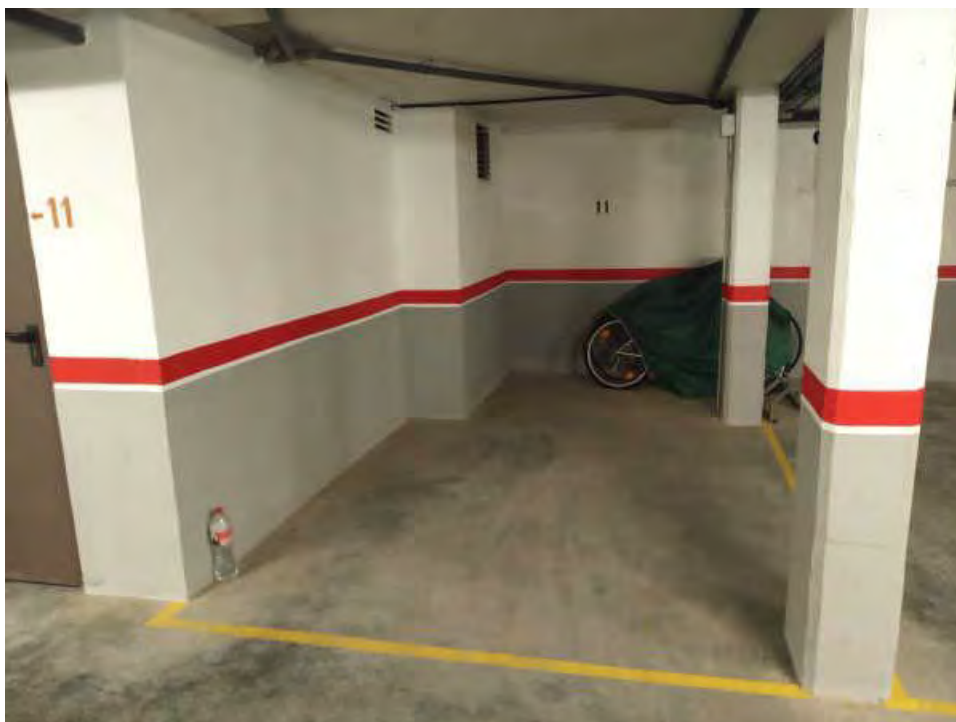

## LOTE 9

### CROQUIS

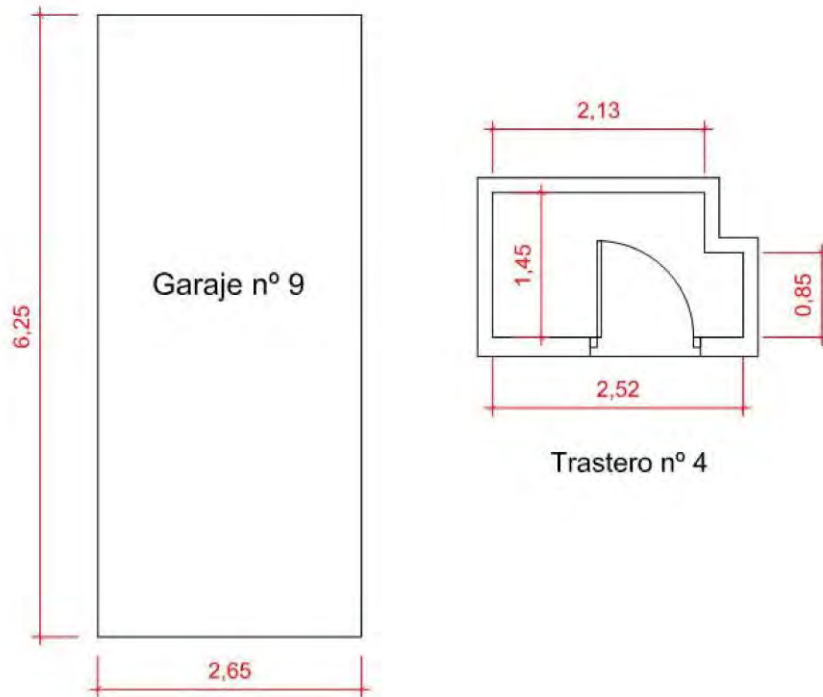

### VISTA EXTERIOR



INTERIOR GARAJE



INTERIOR GARAJE



PLAZA Nº 9



TRASTERO 4



## LOTE 10

### ENTORNO



### EDIFICIO



EXTERIOR PORTAL



PLAZA DE GARAJE



# LOTE 11

## PLANO DE PLANTAS

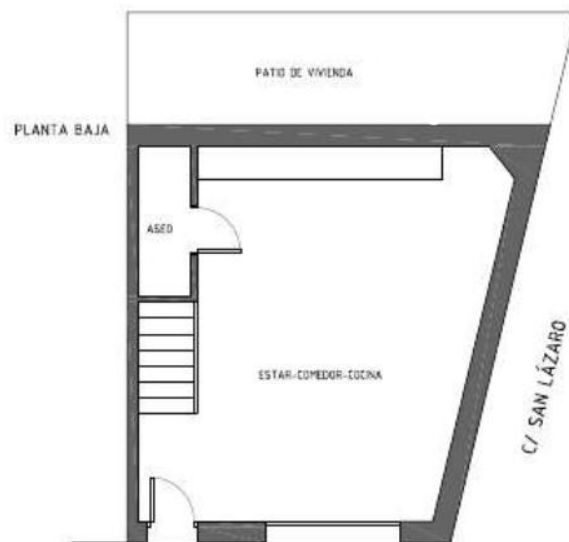
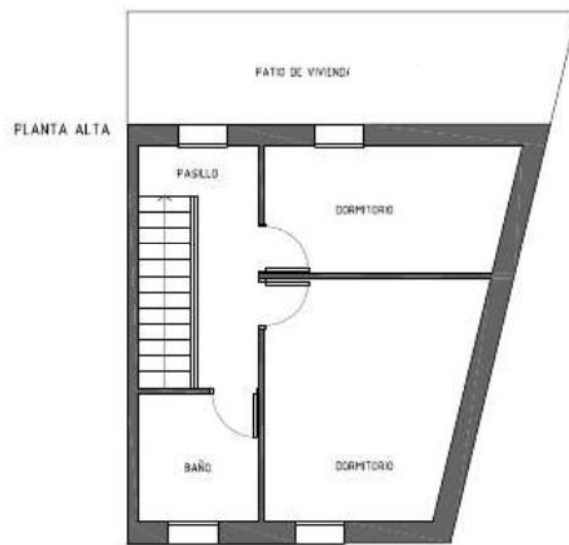



ENTORNO



ENTORNO



ENTORNO



VISTA EXTERIOR



VISTA EXTERIOR



ENTRADA



## VESTÍBULO



## SALÓN-COCINA



SALÓN-COCINA



DORMITORIO 1



DORMITORIO 2



BAÑO



PATIO



# LOTE 12

## EMPLAZAMIENTO

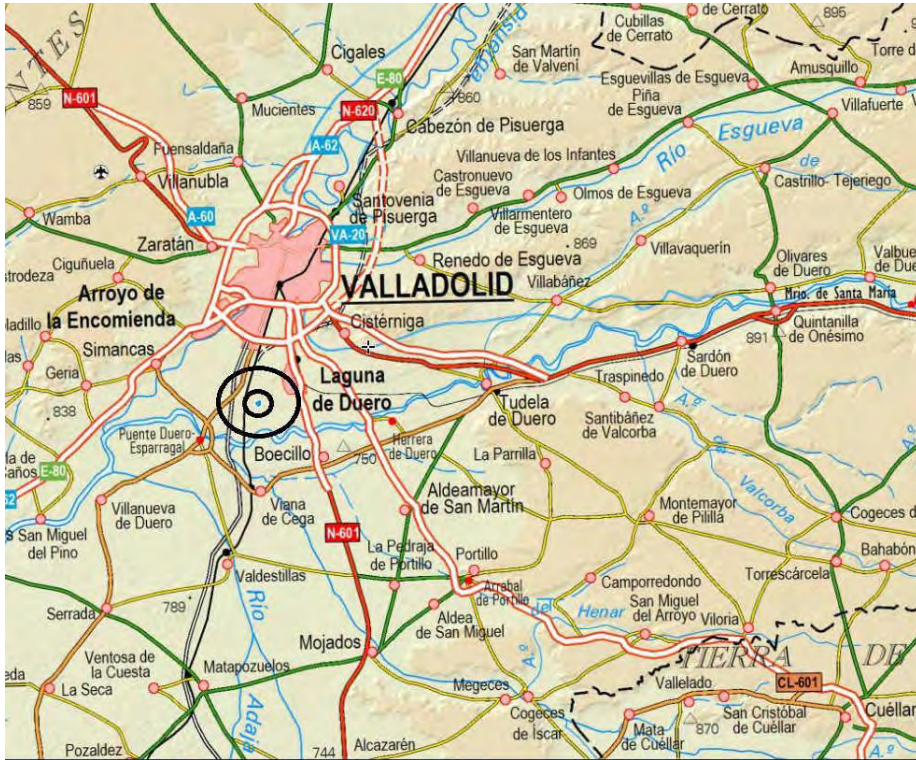



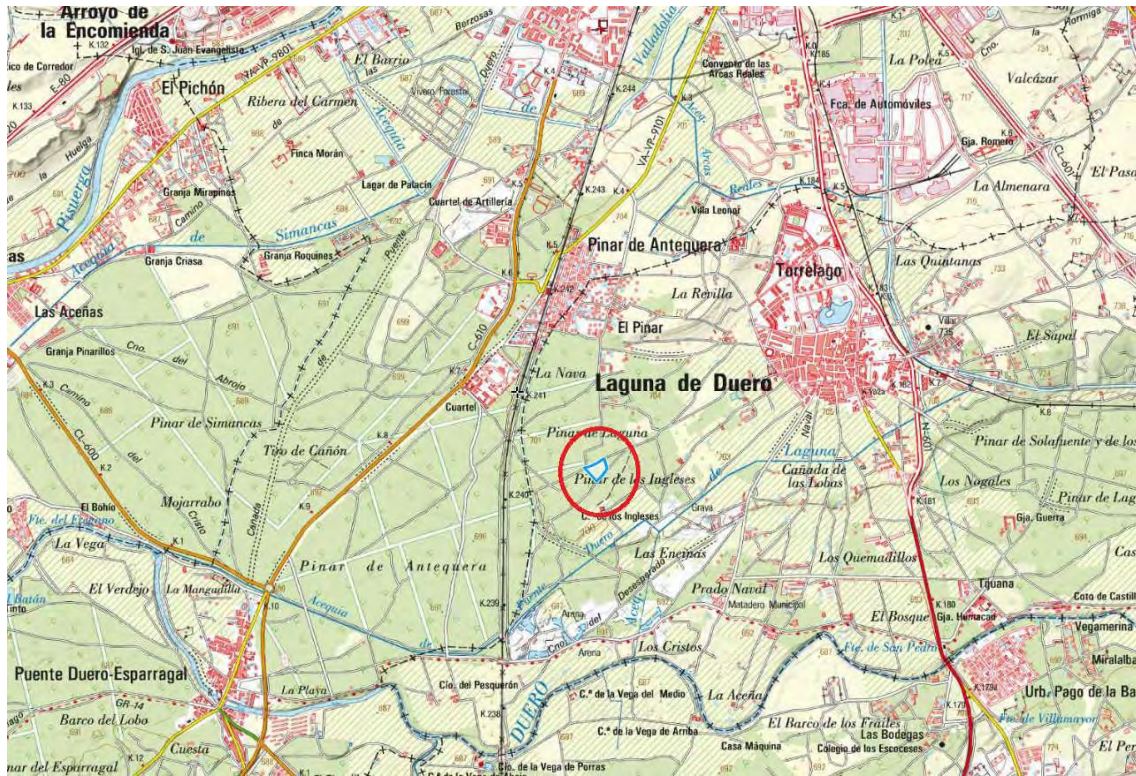

VISTA GENERAL





## LOTE 13

CROQUIS

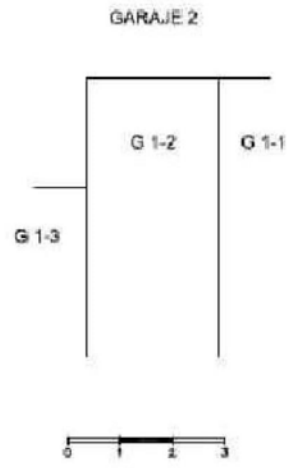

ENTORNO



VIA PRINCIPAL



FACHADA



ENTRADA PORTAL



PLAZA DE GARAJE



ZONA RODADURA

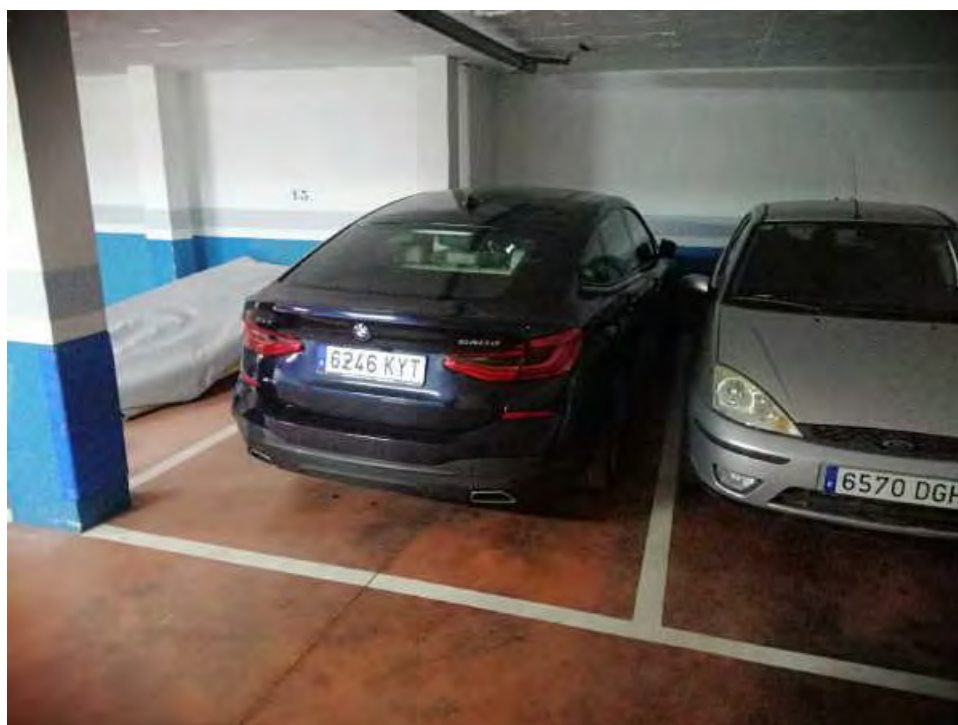

# LOTE 14

## PLANO AMARRES

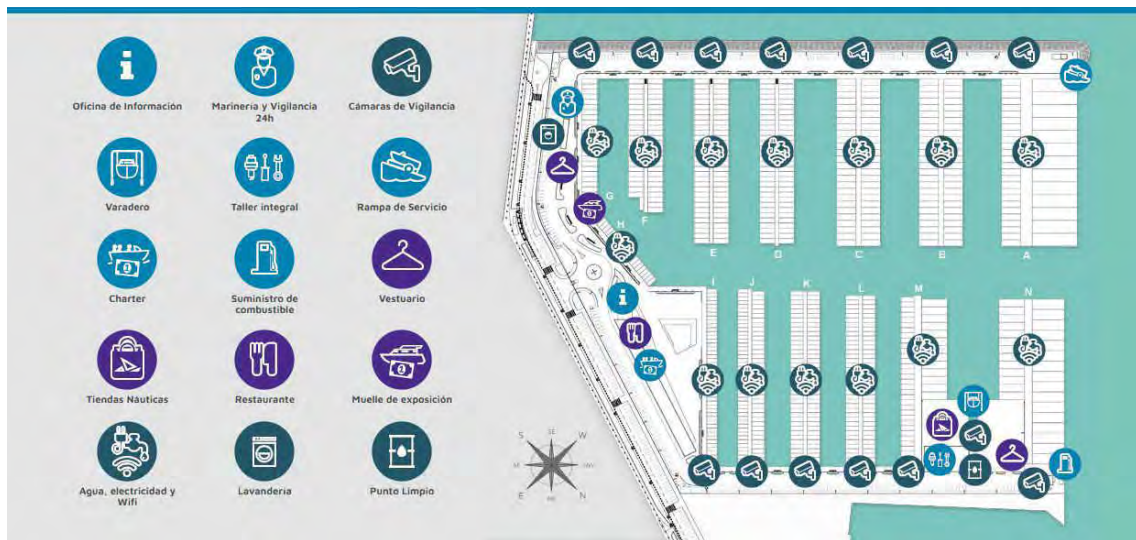
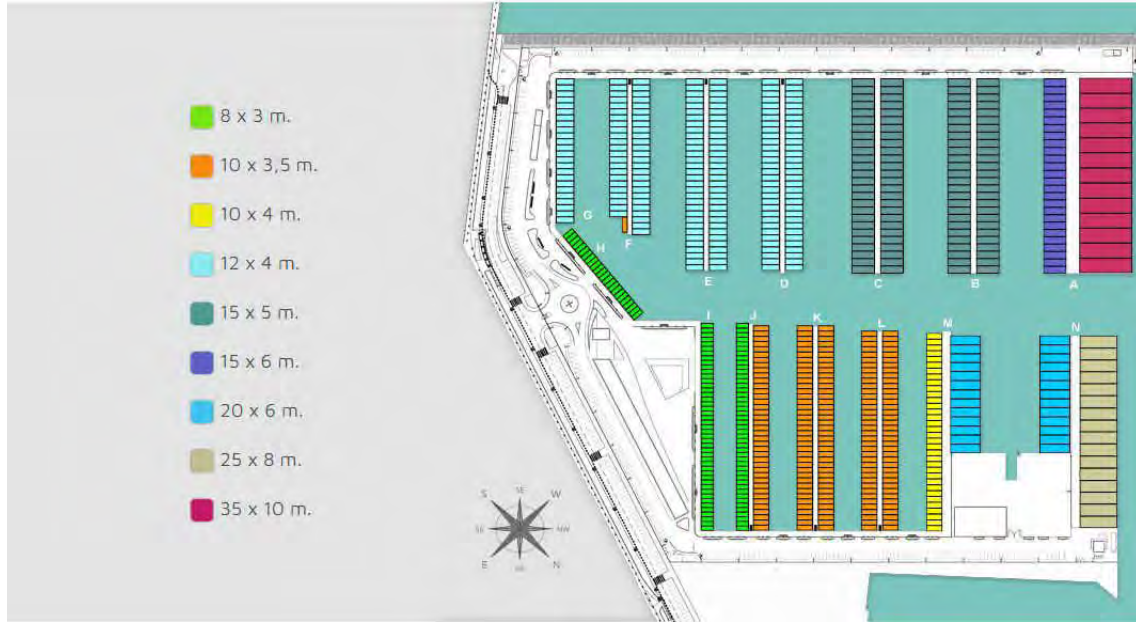

EXTERIOR









ACCESO

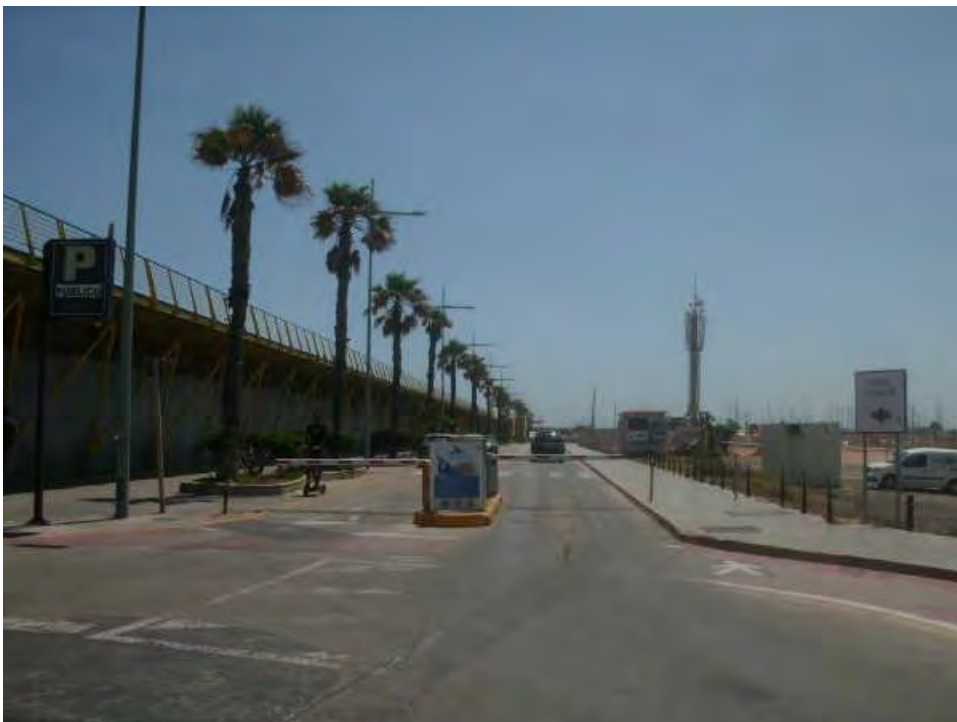



ACCESO PANTALÁN C-2



## LOTE 15

CROQUIS

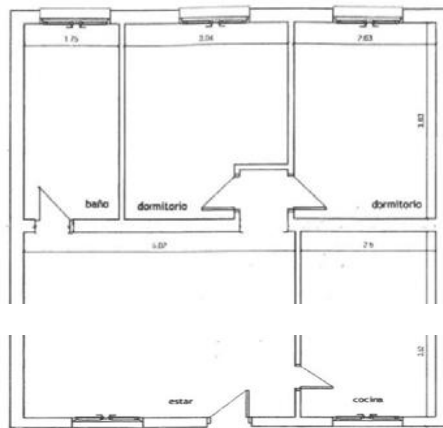

EXP. 481199  
\$50 11800

ENTORNO





ACCESO POR FINCA COLINDANTE





FACHADA





SALÓN





DORMITORIO



COCINA



BAÑO



## TECHOS



## LOTE 16

ENTORNO



FACHADA



## ACCESO A LA URBANIZACIÓN



## ENTORNO URBANIZACIÓN



GARAJE

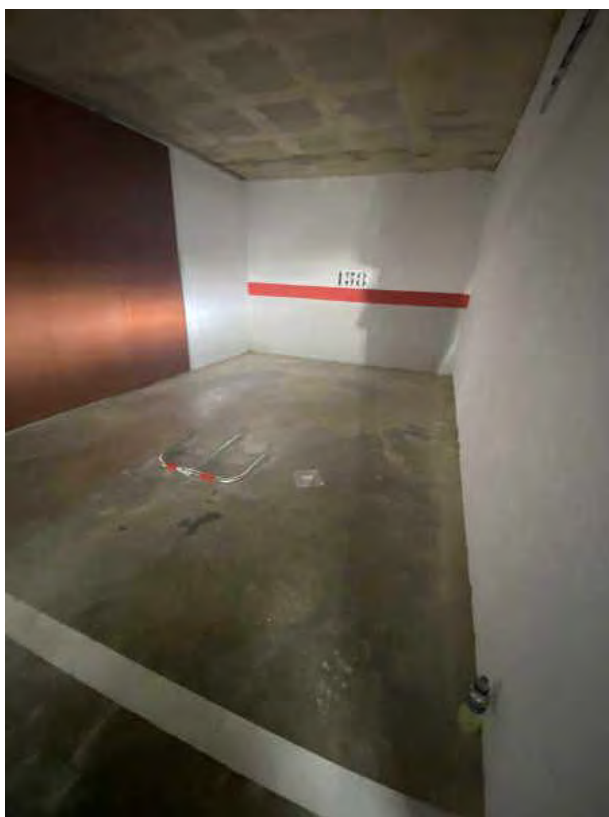

TRASTERO



## ACCESO AL GARAJE



## ENTORNO DEL GARAJE

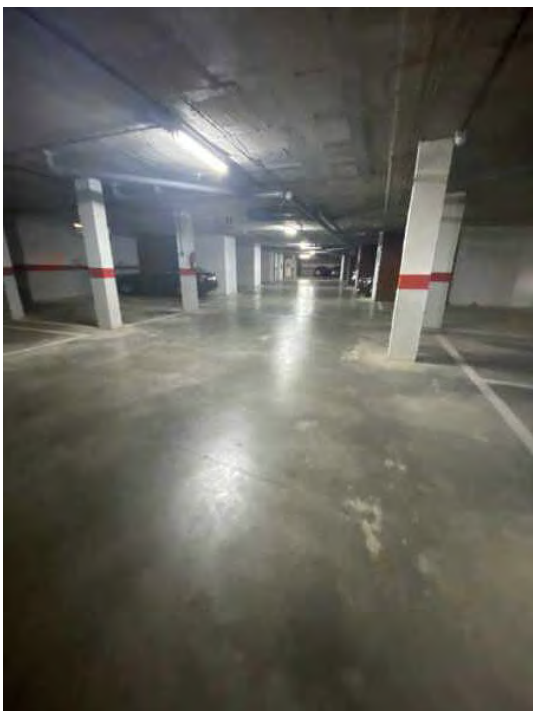

# LOTE 17

## PLANO DE SITUACIÓN



## CROQUIS NAVE

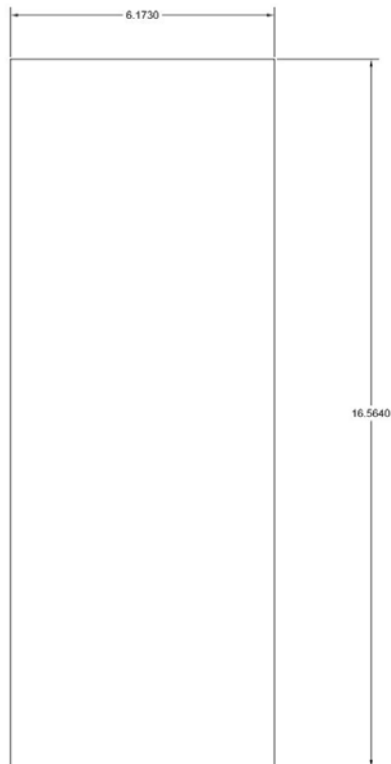



FINCA





NAVE





# LOTE 18

## CROQUIS PLANTA BAJA



PL. BAJA

CROQUIS PLANTA 1ª



PL. PRIMERA



CROQUIS PLANTA 2ª



PL. SEGUNDA



ENTORNO



ENTORNO





FACHADA PRINCIPAL



FACHADA PRINCIPAL



FACHADA PRINCIPAL



FACHADA POSTERIOR



FACHADA POSTERIOR



FACHADA POSTERIOR



CALLE POSTERIOR



INTERIOR















